



ROLL UPS

Manufacturer of Steel Roll - Up Doors

DO NOT CUT THE STRAPS

CRITICAL DIMENSIONS

BUILDER OPENING - 2650mm Wide X 2700mm High
CURTAIN WIDTH - 2700mm

REQUIREMENTS



PARTS INCLUDED

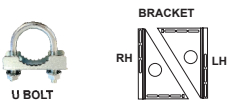
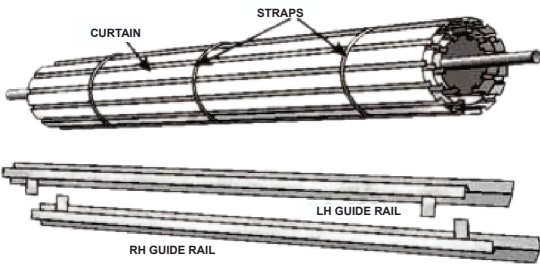

1

MEASURE DOOR OPENING

DO NOT CUT THE STRAPS

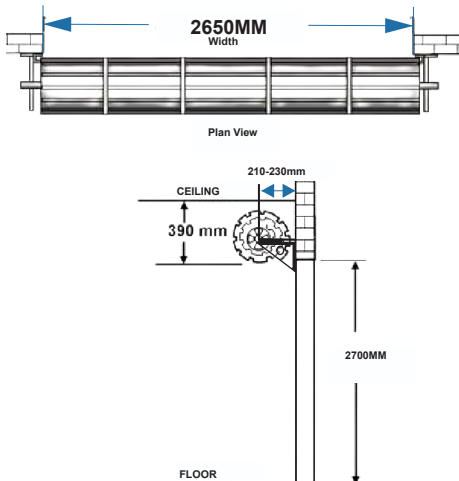

2

INSTALLING GUIDE RAILS

DO NOT CUT THE STRAPS

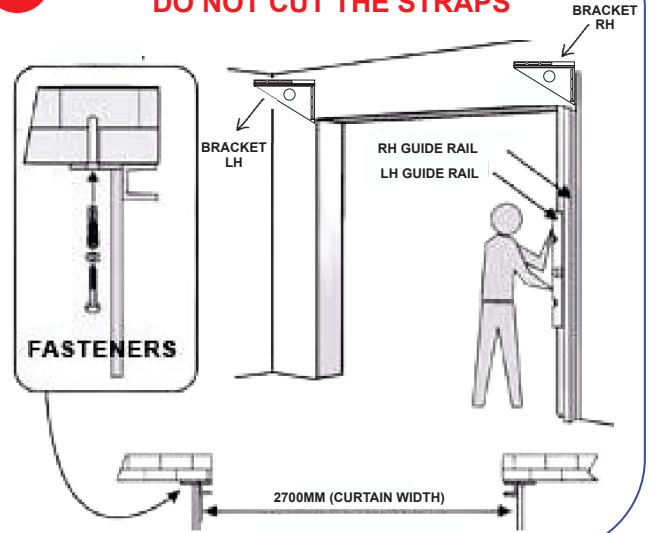

3

ALIGNMENT OF CURTAIN

DO NOT CUT THE STRAPS

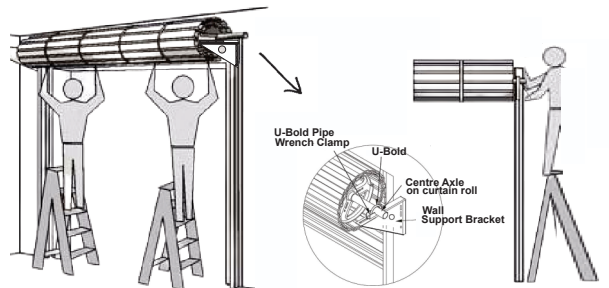

4

INSERTING CURTAIN INTO GUIDE RAILS

YOU CAN NOW CUT THE STRAPS

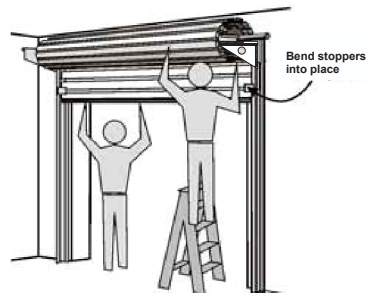

SETTING THE SPRING TENSION

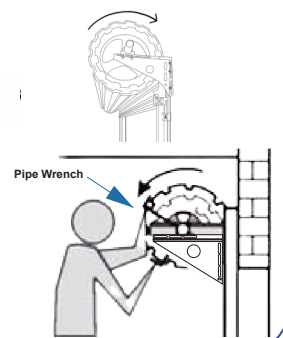

5

SETTING LOCKING BARS



Drill holes for locking bars

AFTER INSTALLATION MAINTENANCE

ALL DOORS

- Do not apply grease or oil to the door guides.
- Periodic wiping of the inside of the guides with methylated spirits is beneficial and polishing (car polish) of the inside surfaces assists smooth door operation.
- Powdered graphite periodically applied to the lock key-way is recommended and necessary, light lubrication of the locking bar retainers is suggested.
- It is advisable, particularly in corrosive areas, to wash your door, including the top, the door roll, with a cloth and water as regularly as you wash your car. This will maintain the surface free from corrosive deposits, giving your door longer life and more lasting appearance. (One tablespoon paraffin to a bucket of water)

GALVANISED DOORS

Painting: Refer to your local paint specialist for expert advice.

CHROMODEK DOORS

Touch up paint. Only Chromodek paint must be used for touch-up of these doors. This paint can be obtained from your local paint dealer.